



PLAYPARC

NEOSPIEL®

So funktioniert {Spiel}

## Spielanlage Bad Driburg Ferrum

09.24.381/382



### ACHTUNG:

Lesen Sie die gesamte Montageanleitung aufmerksam durch, bevor Sie mit der Montage beginnen! Ziehen Sie die Schrauben erst fest, wenn die gesamte Einheit zusammen gestellt ist. Beachten Sie beiliegenden Fundamentplan. Das Gerät darf erst nach vollständigem Abbinden der Fundamente zur Nutzung freigegeben werden (mind. 5 Tage)! Vor der Freigabe des Geräts unbedingt ALLE Schraubverbindungen auf Festigkeit prüfen und unbedingt sicher stellen, dass sämtliche Montagehilfsmittel vom Gerät entfernt sind!



### ATTENTION:

Read the entire installation instructions carefully before starting installation! Tighten the screws only fixed when the entire unit is put together. Note accompanying the foundation plan. The device may be released for use only after complete setting of the foundations (min. 5 days)! absolutely ALL screw Before the release of the device on strength and absolutely ensure that all assembly aids have been removed from the device!



### ATTENTION:

Lisez les instructions d'installation entières soigneusement avant de commencer l'installation! Serrer les vis fixes uniquement lorsque l'ensemble de l'unité est mis en place. Remarque accompagnant le plan de fondation. Le dispositif peut être libéré pour une utilisation seulement après la prise complète des fondations (min. 5 jours)! absolument vis ALL Avant la sortie de l'appareil sur la force et absolument veiller à ce que toutes les aides d'assemblage ont été retirés de l'appareil!



### ATENCIÓN:

Leer las instrucciones antes de comenzar la instalación. Apretar los tornillos fijos únicamente cuando la estructura esté totalmente ensamblada. Se acompaña plano de cimentación. Asegúrese de que los cimientos de hormigón están suficientemente endurecido antes del primer uso. (min.5 días) Asegurarse de que se eliminan todos los auxiliares de montaje antes de usar!



PLAYPARC

NEOSPIEL®

So funktioniert {Spiel}



**ATTENZIONE:**

Leggere l'intero istruzioni di installazione prima di iniziare l'installazione! Serrare le viti di fissaggio solo quando l'intera unità è messo insieme. Si noti che accompagna il piano di fondazione. Il dispositivo può essere rilasciato per l'uso solo dopo l'impostazione completa della fondamenta (min. 5 giorni)! assolutamente TUTTO vite prima del rilascio del dispositivo sulla forza e assolutamente garantire che tutti gli aiuti di assemblaggio sono stati rimossi dal dispositivo!



**VARNING:**

Läs hela monteringsanvisningen noga innan monteringen påbörjas! Dra åt skruvarna endast fasta när hela enheten sätts ihop. Observera medföljande grunden planen. Enheten får övergå till bruk efter fullständig inställning av fundament (min. 5 dagar)! absolut alla skruv före utgivningen av enheten på styrka och absolut se till att alla monteringshjälp har tagits bort från enheten!



**POZOR:**

Natančno preberite celotna navodila za namestitvev pred začetkom nameščanja! Privijte vijake fiksne šele, ko je celotna enota skupaj. Opomba priložen načrt temelj. Naprava se lahko sprosti za uporabo šele po popolni nastavitvi fundacij (min. 5 dni)! absolutno VSE vijak pred sprostitvijo naprave na moč in absolutno zagotovi, da so bili vsi sestavljanja pomagala odstraniti iz naprave!



**ATENȚIE:**

Citiți instrucțiunile de instalare întregi cu atenție înainte de a începe instalarea! Strângeți șuruburile numai fixe atunci când întreaga unitate este pus împreună. Notă care însoțește planul de fundație. Dispozitivul poate fi eliberat pentru a fi utilizate numai după setarea completă a fundațiilor (min. 5 zile)! absolut toate celelalte șuruburi Înainte de lansarea dispozitivului pe forță și să se asigure că absolut toate ajutoarele de asamblare au fost scoase din aparat!



**OPREZ:**

Pročitajte čitavu instalaciju upute pažljivo prije pokretanja instalacije! Stegnite vijke fiksne tek kada je cijela jedinica je staviti zajedno. Napomena prateći plan temelj. Uređaj se može pustiti u upotrebu samo nakon potpunog postavljanje temelja (min. 5 dana)! Apsolutno SVE vijak Prije puštanja uređaja na snagu i apsolutno bi se osiguralo da su sve preinake koje pomagala su uklonjene iz uređaja!



**ΠΡΟΣΟΧΗ:**

Διαβάστε ολόκληρο οδηγίες εγκατάστασης προσεκτικά πριν ξεκινήσετε την εγκατάσταση! Σφίξτε τις βίδες σταθερό μόνο όταν ολόκληρη η μονάδα είναι μαζί. Σημείωμα που συνοδεύει το σχέδιο θεμελίωσης. Η συσκευή μπορεί να απελευθερωθεί για χρήση μόνο μετά την πλήρη ρύθμιση της θεμέλια (min. 5 ημέρες)! απολύτως όλα βίδα Πριν από την κυκλοφορία της συσκευής στην αντοχή και απόλυτα διασφαλίσει ότι όλα τα βοηθήματα συναρμολόγησης έχουν αφαιρεθεί από τη συσκευή!



**ВНИМАНИЕ:**

Прочети цялата инструкции за инсталиране внимателно преди започване на инсталация! Затегнете винтовете фиксирани само когато целият блок се поставя заедно. Имайте предвид, придружаваща плана за фундамент. Устройството може да бъде пуснато в употреба само след пълна настройка на основи (мин. 5 дни)! абсолютно всички винтови Преди пускането на устройството на сила и абсолютно гарантира, че всички монтажни помощи са били отстранени от устройството!



**DİKKAT:**

Kuruluma başlamadan önce dikkatlice tüm kurulum talimatlarını okuyun! Tüm birim araya olduğunda sadece sabit vidaları sıkın. Vakıf planı eşlik edin. Cihaz sadece temelleri tam ayarında sonra kullanılmak üzere serbest bırakılabilir (min. 5 gün)! kesinlikle TÜM gücüne cihazın yayımlanmasından önce vida ve kesinlikle tüm montaj yardımcıları cihazdan çıkarıldığından emin olun!



**LET OP:**

Lees de installatie-instructies zorgvuldig door voordat u begint met de montage. Draai de schroeven pas volledig vast wanneer het toestel geheel is gemonteerd. Leest u het bijgeleverde montageplan aandachtig door. Het toestel kan pas vrijgegeven worden voor gebruik na de volledige uitharding van de fundatie. (minimaal 5 dagen). Voordat het toestel wordt vrijgegeven dient u nogmaals alle schroefverbindingen zorgvuldig te controleren en zo nodig vast te draaien. Verwijder alle montagehulpmiddelen van het toestel voor gebruik.



**ADVARSEL:**

Læs hele installationsvejledningen omhyggeligt inden installation! Spænd skruerne kun faste, når hele enheden er sat sammen. Bemærk ledsager fundamentet planen. Enheden kan frigives til brug efter fuldstændig indstilling af fundamenter (min. 5 dage)! absolut ALLE skruer Før udgivelsen af enheden på styrke og absolut sikre, at alle montage hjælpemidler er blevet fjernet fra enheden!



**FORSIKTIG:**

Les hele installasjonsveiledningen nøye før du starter installasjonen! Stram skruene bare faste når hele enheten er satt sammen. Merk følger grunnlaget plan. Enheten kan bli friggitt for bruk kun etter fullstendig innstilling av fundamenter (min. 5 dager)! absolutt ALLE skruer Før utgivelsen av enheten på styrke og absolutt sikre at alle monteringshjelpemidler er fjernet fra enheten!



**VAROITUS:**

Lue koko asennusohje huolellisesti ennen asennuksen aloittamista! Kiristä ruuvit vain kiinteä, kun koko laite on koottu. Huomaa mukana perusta suunnitelma. Laite voidaan luovuttaa käyttöön vasta sen jälkeen, kun täydellinen asetus perustusten (min. 5 päivää)! ehdottomasti KAIKKI ruuvi Ennen vapauttamista laitteen vahvuus ja ehdottomasti varmistettava, että kaikki kokoonpanon tuet on poistettu laitteesta!



**UWAGA:**

Przeczytać całą instrukcję instalacji uważnie przed rozpoczęciem instalacji! Dokręcić śruby tylko stałe, kiedy całe urządzenie jest połączone. Uwaga towarzyszące plan fundamentu. Urządzenie może być dopuszczane do użytku dopiero po całkowitym otoczeniu fundamentów (min. 5 dni)! absolutnie przykręcić Przed zwolnieniem urządzenia na wytrzymałość i całkowicie zapewnić, że wszystkie środki wspomagające montaż zostały usunięte z urządzenia!



**VIGYÁZAT:**

Olvassa el a teljes telepítési utasításokat a telepítés megkezdése előtt! Húzza meg a csavarokat csak meg határozni, ha az egész egységet össze. Megjegyzés kísérelő alapozási tervet. Az eszköz felszabadítható csak teljes rögzítése alapjait (min. 5 nap)! abszolút minden csavar felszabadítása előtt, a berendezés szilárdsága és teljesen arról, hogy szerelési segédesszközöket már eltávolították a készüléket!



**POZOR:**

Přečíst celý návod k instalaci informací dříve, než zahájením instalace! Utáhnout šrouby fixní pouze tehdy, když je celý přístroj dohromady. Všimněte si, doprovázející Plan Foundation. Zařízení může být uvolněna k použití teprve po úplném nastavení základů (min. 5 dní)! naprosto všechny šroubové Před uvolněním zařízení na pevnost a zcela zajistit, aby všechny montážní pomůcky byly odstraněny ze zařízení!!



**CUIDADO:**

Leia as instruções de instalação inteira cuidadosamente antes de iniciar a instalação! Apertar os parafusos única fixos quando toda a unidade é colocada em conjunto. Nota que acompanha o plano de fundação. O dispositivo pode ser liberado para uso somente após a definição completa do fundações (min. 5 dias)! absolutamente todos os parafusos Antes do lançamento do dispositivo sobre a força e absolutamente assegurar que todos os auxiliares de montagem ter sido removido do dispositivo de!



PLAYPARC



NEOSPIEL®

So funktioniert {Spiel}

|  | Platzbedarf                          | Fallraum                  | Max. freie Fallhöhe                        | Gesamthöhe         | Empfohlene Altersgruppe         | Fundamente   | schwerstes Teil/ Gesamtgewicht | Lieferumfang                    | Packmaße                      |
|--|--------------------------------------|---------------------------|--|--------------------|---------------------------------|--------------|--------------------------------|---------------------------------|-------------------------------|
|  | Space requirement                    | Impact area               | Free fall height                           | Total height       | Recommended age group           | foundations  | Heaviest part/ Total weight    | Scope of delivery               | Packing measures              |
|  | Espace requis                        | Cas de l'espace           | Hauteur de chute                           | Hauteur totale     | Groupe d'âge recommandée        | Fondations   | Partie plus lourde             | Contenu de la livraison         | Mesures d'emballage           |
|  | Espacio requerido                    | área de impacto           | Altura de caída                            | Altura total       | Grupo de edad recomendado       | Fundamentos  | Parte más pesada               | Volumen de suministro           | Medidas de embalaje           |
|  | Requisiti di spazio                  | Spazio case               | Altezza di caduta                          | Altezza totale     | Gruppo d'età consigliata        | Fondazioni   | Più pesante                    | Dotazione di forniture          | Misure dell'imballaggio       |
|  | Rörelse område                       | Stötdämpande underlag     | Fri fallhöjd                               | Total höjd         | Rekomenderad åldersgrupp        | Fundament    | Tyngst del                     | Leveransomfattning              | Förpackning åtgärder          |
|  | Prostorskih zahtev                   | primeru prostora          | prosta višina padca                        | Skupna višina      | priporočen starostni skupini    | Temelje      | Najtežji del                   | Obseg dobave                    | Pakiranje ukrepi              |
|  | Cerintele spațiului                  | Suprafața de impact       | Înălțimea de cadere                        | Înălțimea totală   | Grupa de vârstă recomandată     | Fundații     | Cea mai grea piesă             | Scopul livrării                 | Măsurile de ambalare          |
|  | Vrije ruimte / afmeting speeltoestel | Obstakel vrije ruimte     | Valhoogte                                  | Totale hoogte      | Leeftijdscategorie              | Stichtingen  | Zwaarste deel                  | Levertijd                       | Maatregelen van de verpakking |
|  | Pladskravene                         | Indvirkning område        | Fri højde af fald                          | Total højde        | Anbefalet aldersgruppe          | Fundamenter  | tungeste del                   | Anvendelsesområdet for levering | Pakning foranstaltninger      |
|  | Arealkrav                            | Sikkerhetsareal           | Fallhøyde                                  | Totalhøyde         | Aldersgruppe                    | Fundament    | Tyngste delen                  | Leveranseomfang                 | Pakking tiltak                |
|  | Tilantarve                           | Lasku puhdistuma          | Vapaa korkeus Fall                         | Korkeus yhteensä   | Suosittelut ikäryhmässä         | Säätiöt      | Rankin kohta                   | Toimitukseen                    | Pakkaus toimenpiteet          |
|  | Wymagania dotyczące miejsca          | Upadek luzu               | Wolna wysokość upadku                      | Całkowita wysokość | Zalecany Wiek grupy             | Fundacje     | Najcięższe części              | Zakres dostawy                  | Pakowania środków             |
|  | Helyigény                            | Őszén-szabadtér           | Ingyenes esési magasság                    | Teljes magassága   | Ajánlott korosztály             | Alapítványok | legnehezebb része              | A szállítási csomag része       | Csomagolás intézkedések       |
|  | případ prostoru ...                  | případ prostoru           | volná výška pádu                           | Celková výška      | Doporučená věková skupina       | Základy      | Nejtěžší část                  | Rozsah dobavy                   | Balení opatření               |
|  | Requisitos de espaço                 | caso do espaço            | Altura livre de queda                      | Altura total       | Faixa etária recomendada        | Fundações    | Parte mais pesada              | Escopo de fornecimento          | Medidas da embalagem          |
|  | potreba za prostorom                 | Jesen klirens             | Najviše slobodnog pada visine              | Ukupna visina      | preporučene dobne skupine       | Zaklada      | najteži dio/ Ukupna težina     | Opseg isporuke                  | Pakiranje mjeregije           |
|  | Απαιτήσεις χώρου                     | Απόσταση από το φθινόπωρο | το ελεύθερο ύψος της πτώσης                | Συνολικό ύψος      | Συνιστώμενη ηλικιακή ομάδα      | Θεμέλια      | βαρύτερο μέρος                 | Έκταση παράδοσης                | Συσκευασία μέτρα              |
|  | Пространствени изисквания            | Падането клирънс          | Свободно пространство с височина на падане | Обща височина      | Препоръчителна възрастова група | Фондации     | най-тежката част               | Обхват на доставка              | Мерки за опаковане            |
|  | Alan gereksinimleri                  | Sonbahar Gümrükleme       | sonbaharın ücretsiz yüksekliği             | Toplam yükseklik   | Önerilen yaş grubu              | Vakıflar     | En ağır bölümü                 | Teslimat kapsamı                | Ambalaj önlemleri             |



PLAYPARC

NEOSPIEL®

So funktioniert {Spiel}



7,28x5,46x 3,99 (m)



10,13x8,89 (m)



1,50 m



3,99 m



8x50x50x60 (cm)

1x80x40x40

2x40x40x60

3x40x40x40

2x30x30x75

1,84 m³ concrete (C25/30)



4+



~360 kg / ~930 kg



4,15x1,35x2,20 (m)

3,45x1,35x2,20

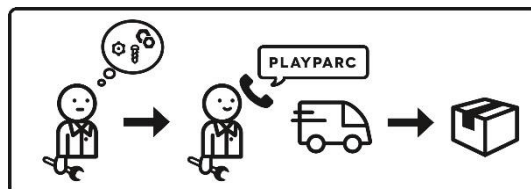
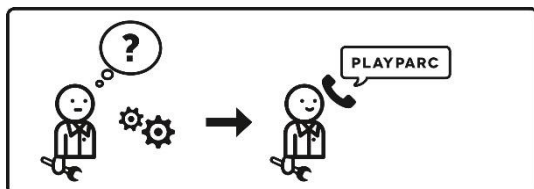

PLAYPARC Allwetter-Freizeit-Anlagenbau GmbH  
Zur Kohlstätte 9 · D-33014 Bad Driburg  
Tel. +49 (0) 52 53 4 05 99-0 · Fax +49 (0) 52 53 4 05 99-10  
info@playparc.de  
www.playparc.de

|       |          |          |          |  |  |  |  |  |  |
|-------|----------|----------|----------|--|--|--|--|--|--|
| Name: | MB       | AD       | MB       |  |  |  |  |  |  |
| Date: | 12.04.17 | 11.07.18 | 18.02.20 |  |  |  |  |  |  |



PLAYPARC



NEOSPIEL®

So funktioniert {Spiel}

1x

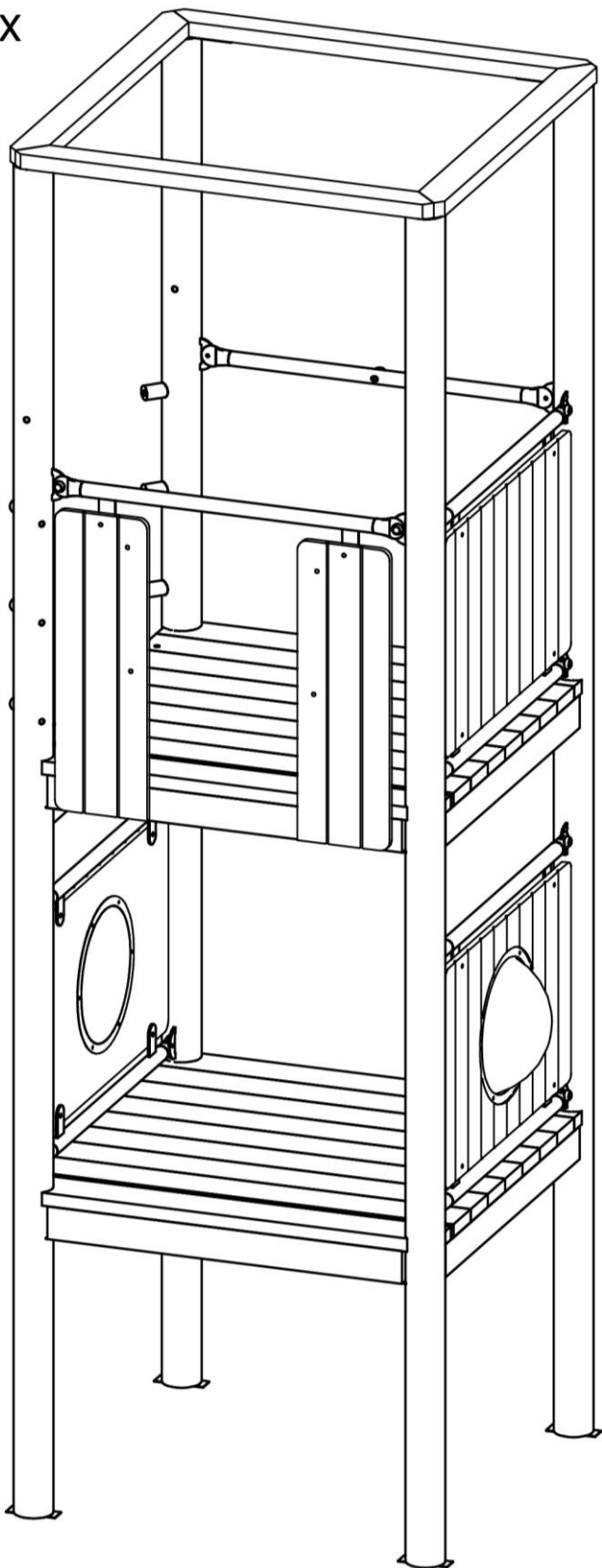

1x

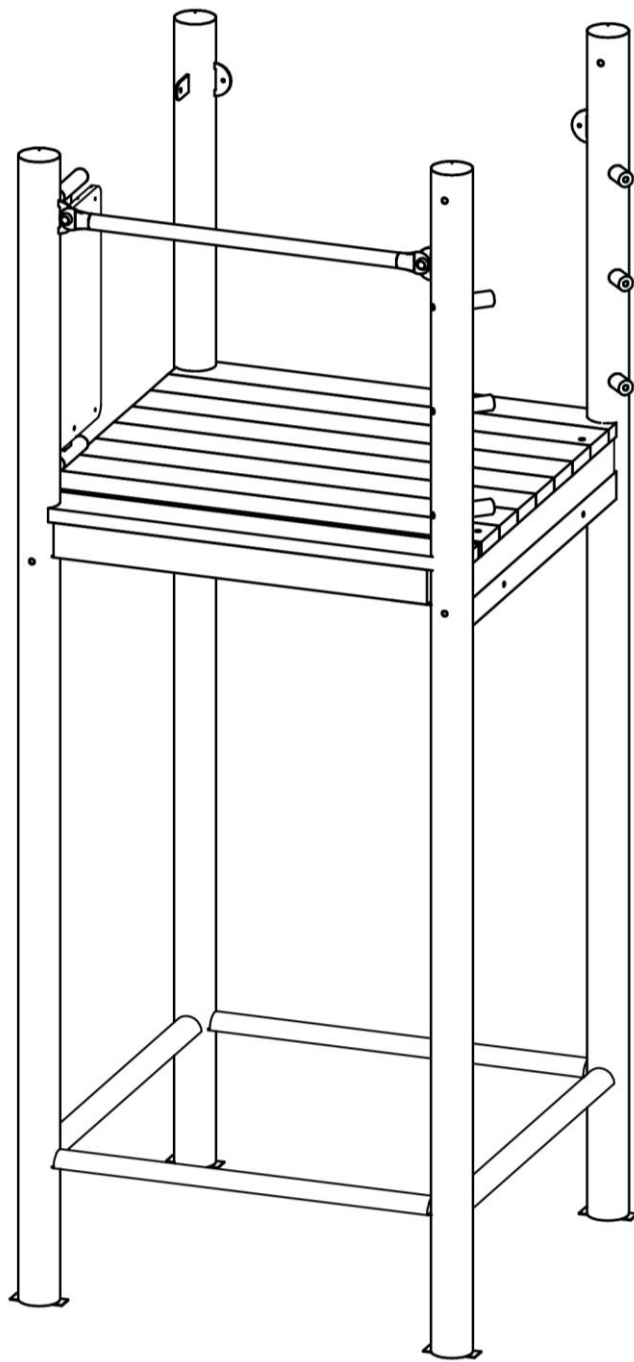



PLAYPARC



NEOSPIEL®

So funktioniert {Spiel}

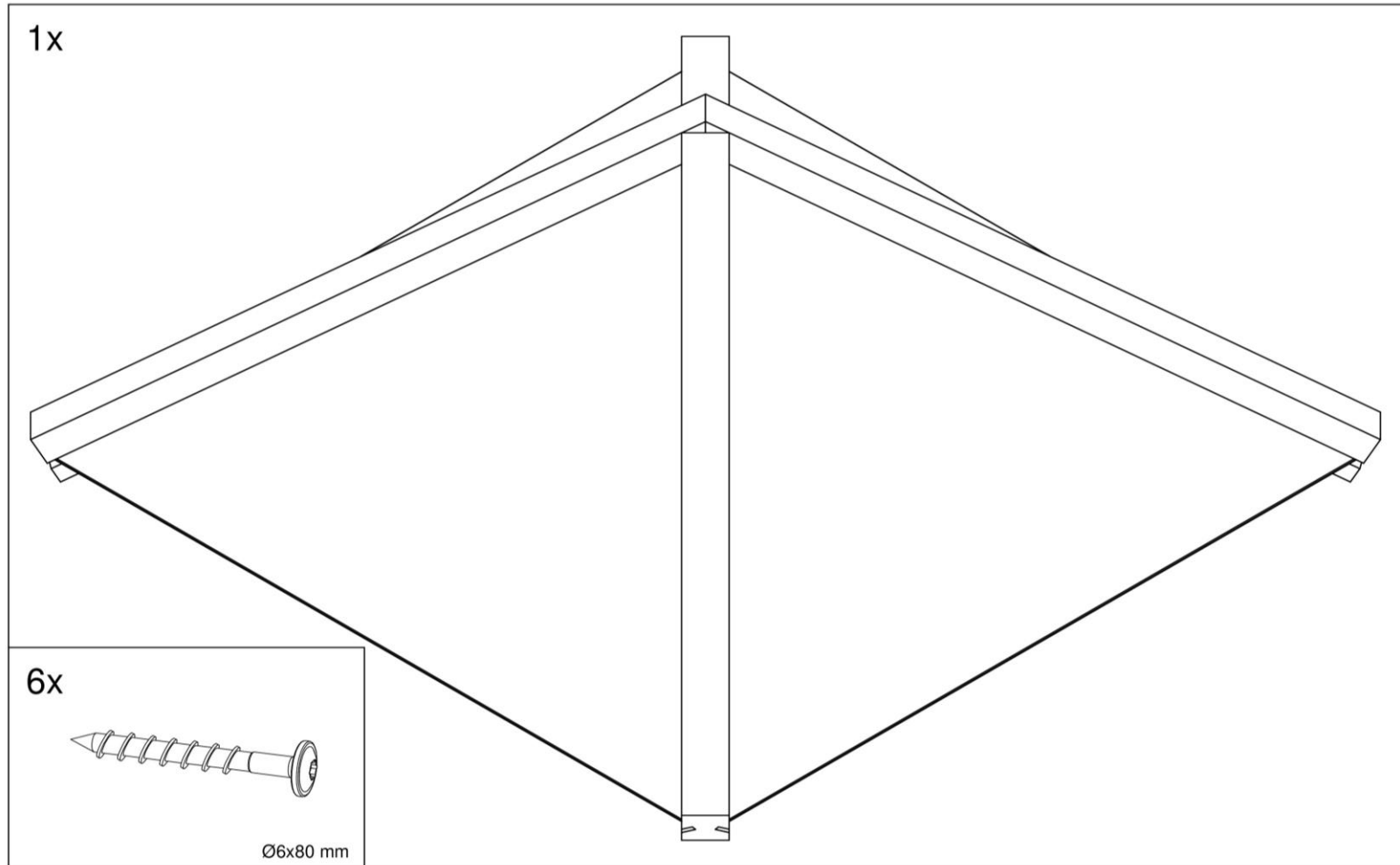



PLAYPARC



NEOSPIEL®

So funktioniert {Spiel}

1x

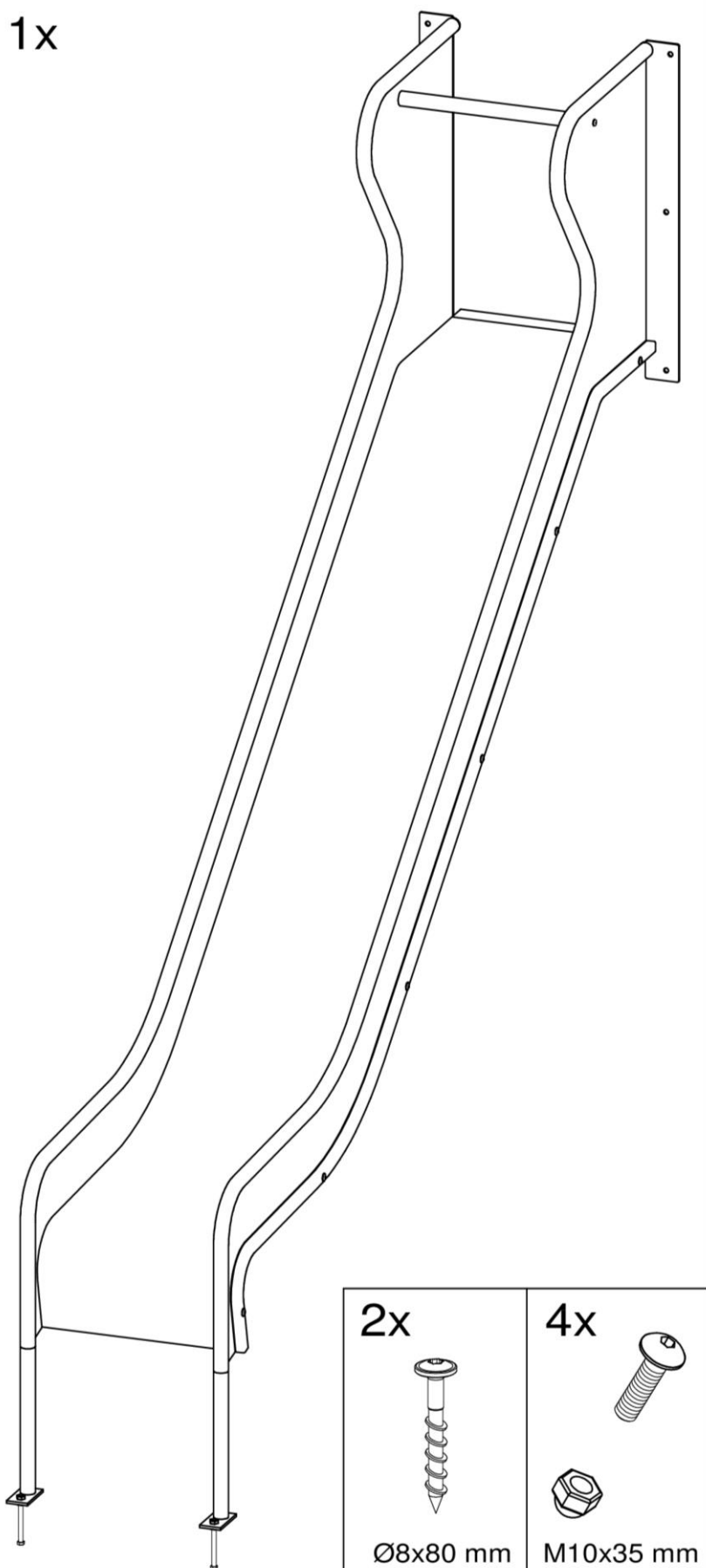

1x

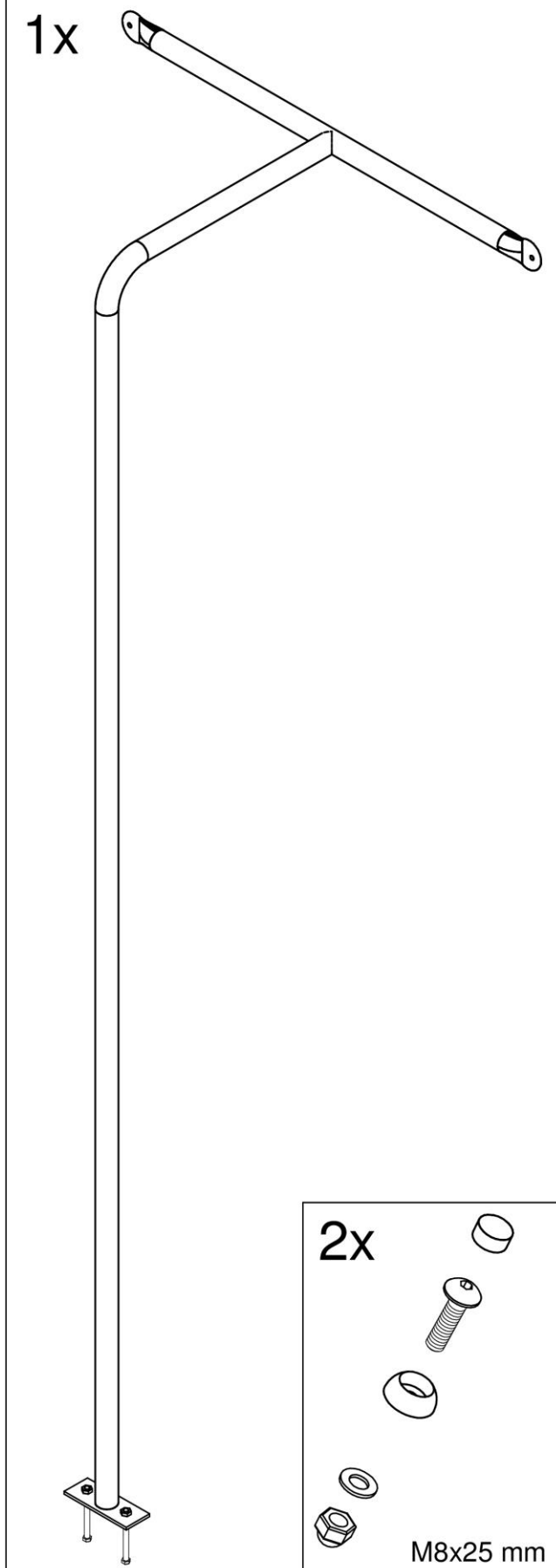







PLAYPARC

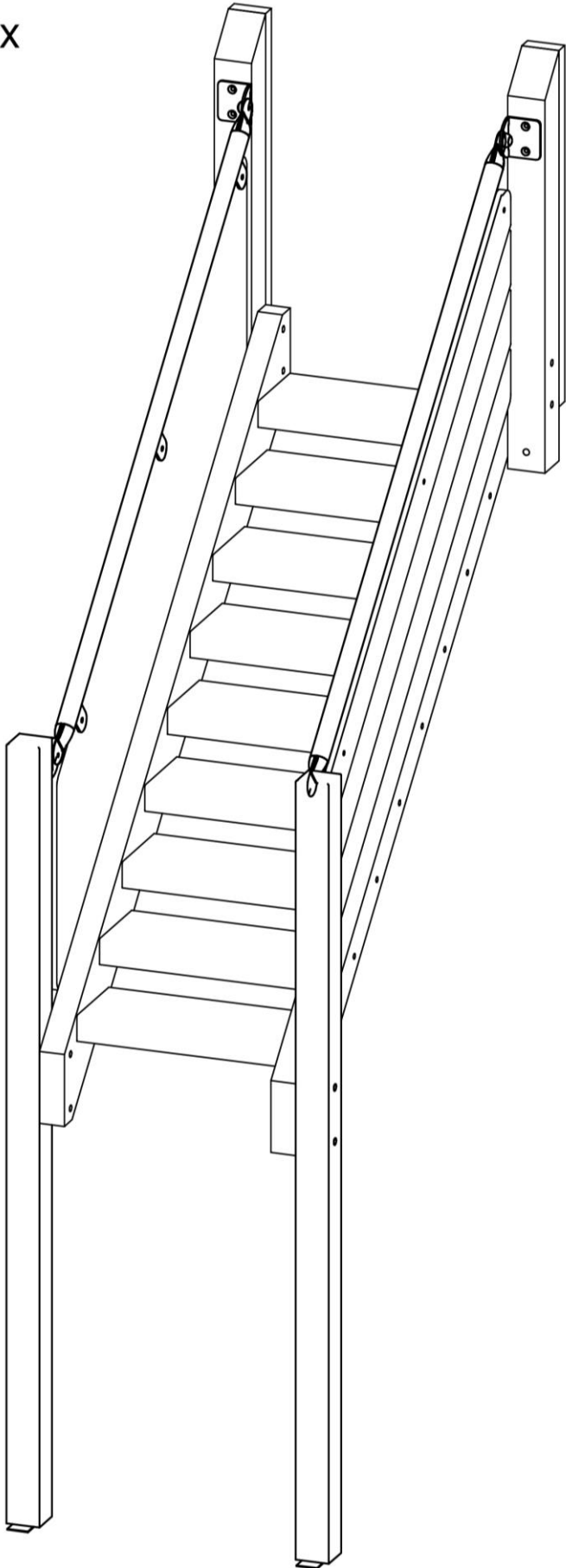
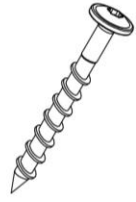

NEOSPIEL®

So funktioniert {Spiel}

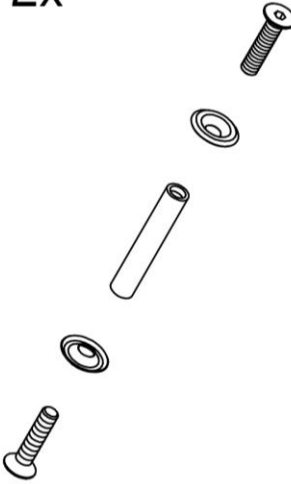
|  |   |
|--|---|
| <p>1x</p>  | <p>1x</p>  <p>Ø8x80 mm</p>     |
|  | <p>2x</p>  <p>Ø6x70 mm</p>   |
|  | <p>2x</p>  <p>M10x160 mm</p> |



PLAYPARC



NEOSPIEL®

So funktioniert {Spiel}

1x

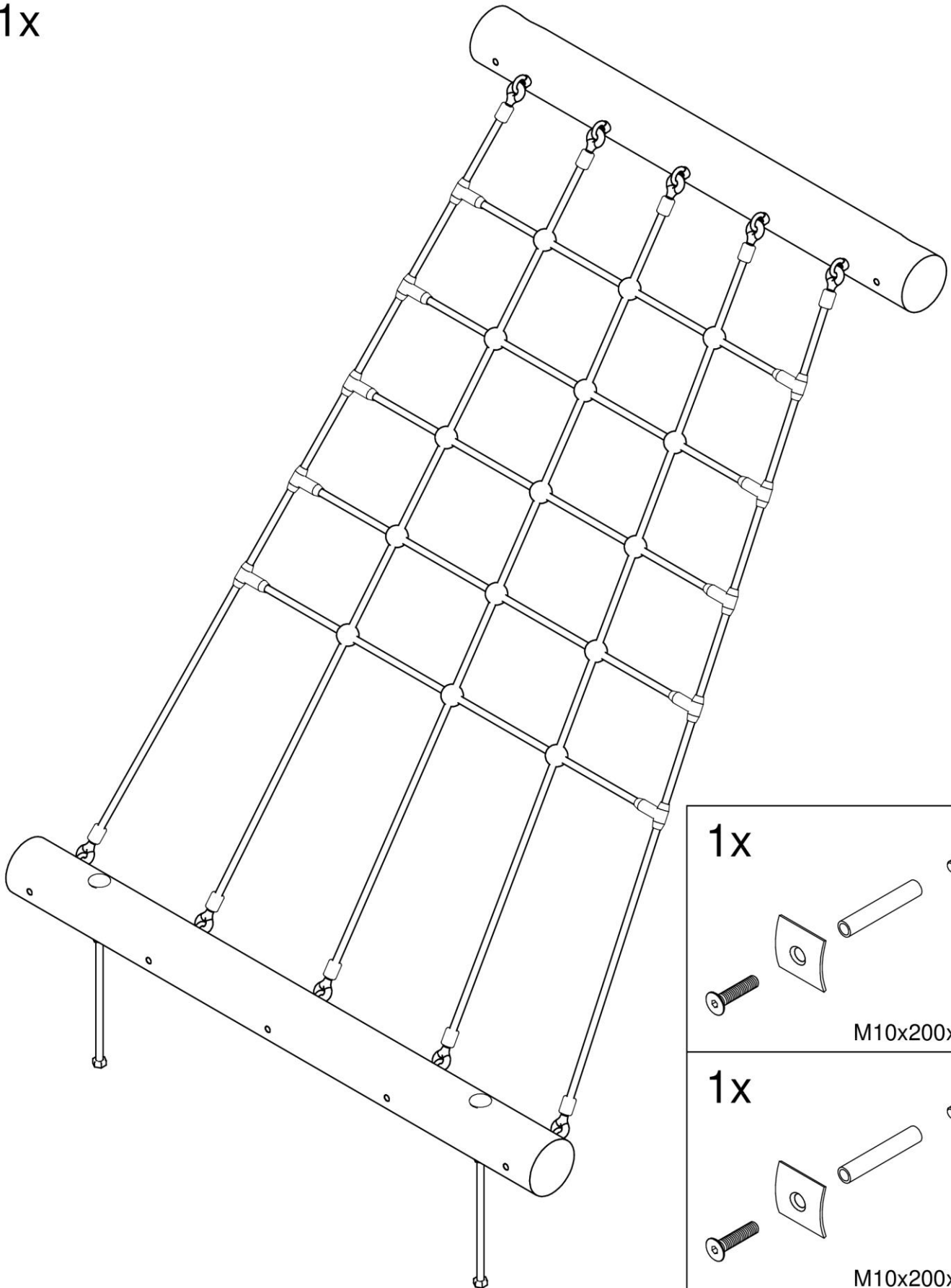

1x

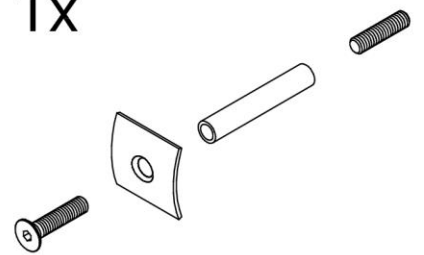

M10x200xmm

1x

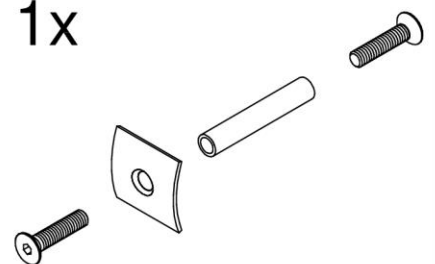

M10x200xmm



PLAYPARC









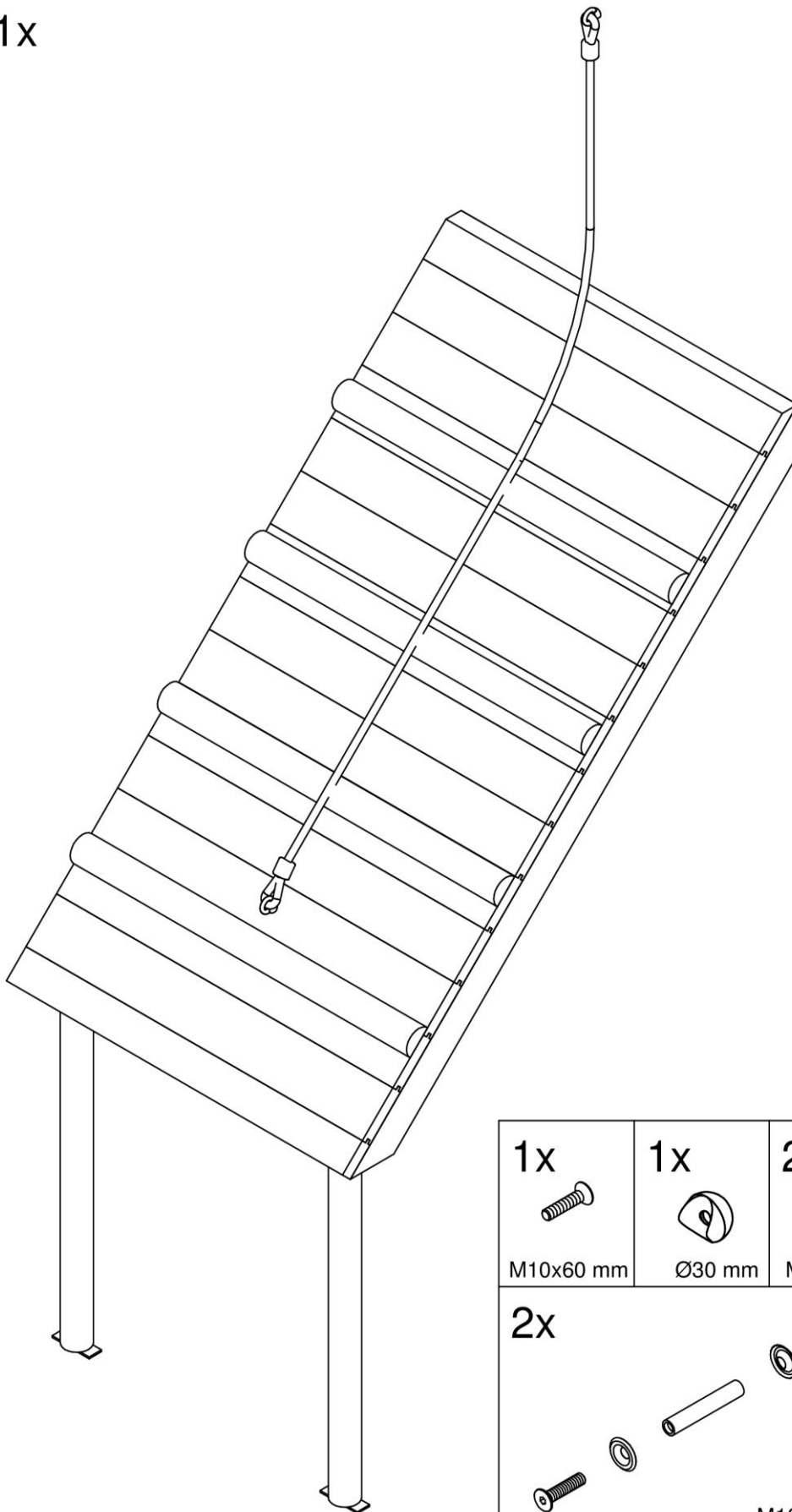

NEOSPIEL®

So funktioniert {Spiel}

1x



|   |   |   |
|---|---|---|
| 1x<br><br>M10x60 mm  | 1x<br><br>Ø30 mm | 2x<br><br>M10x4 mm |
| 2x<br><br><br><br><br><br>M10x120 mm |   |   |



PLAYPARC

NEOSPIEL®

So funktioniert {Spiel}

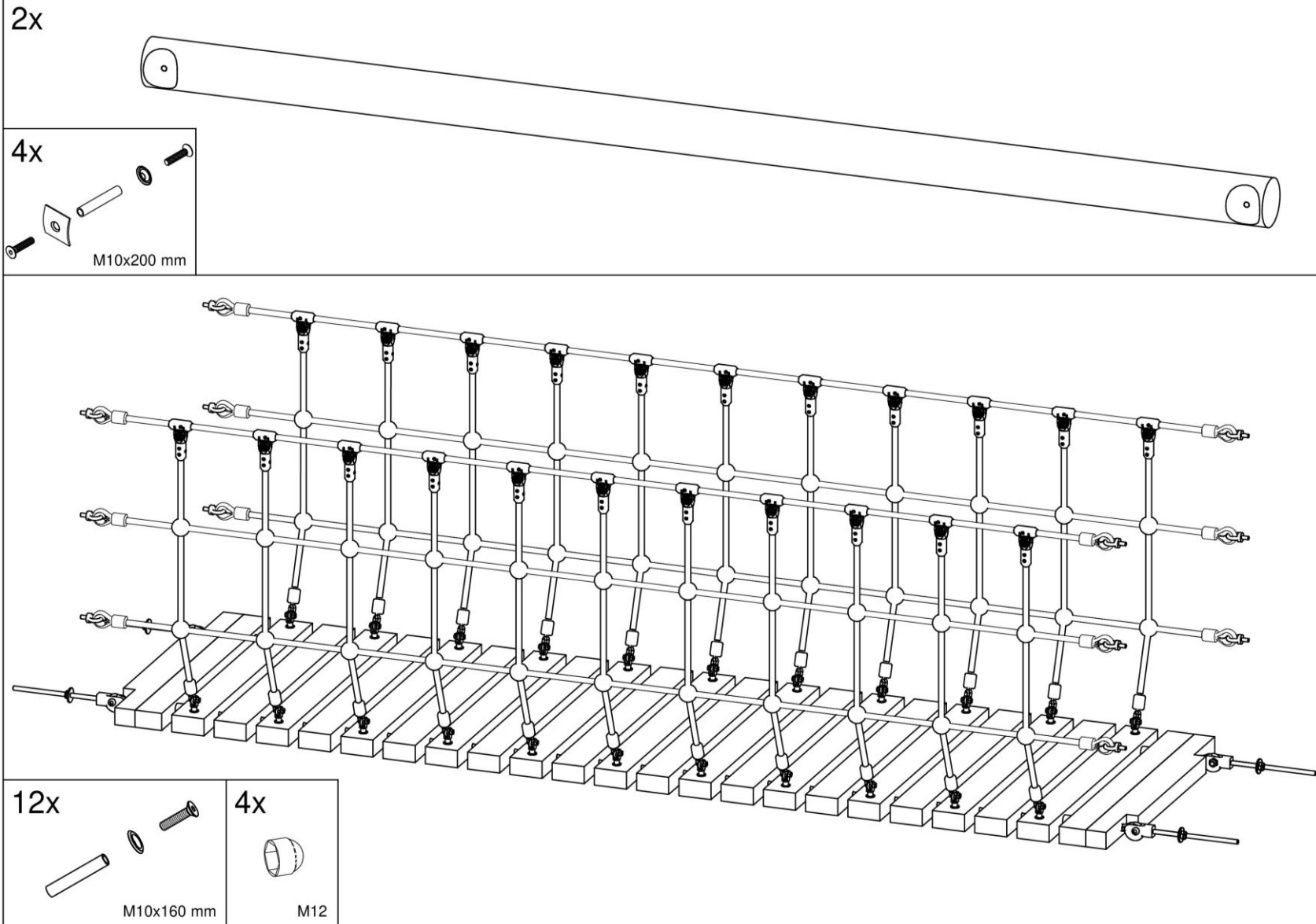

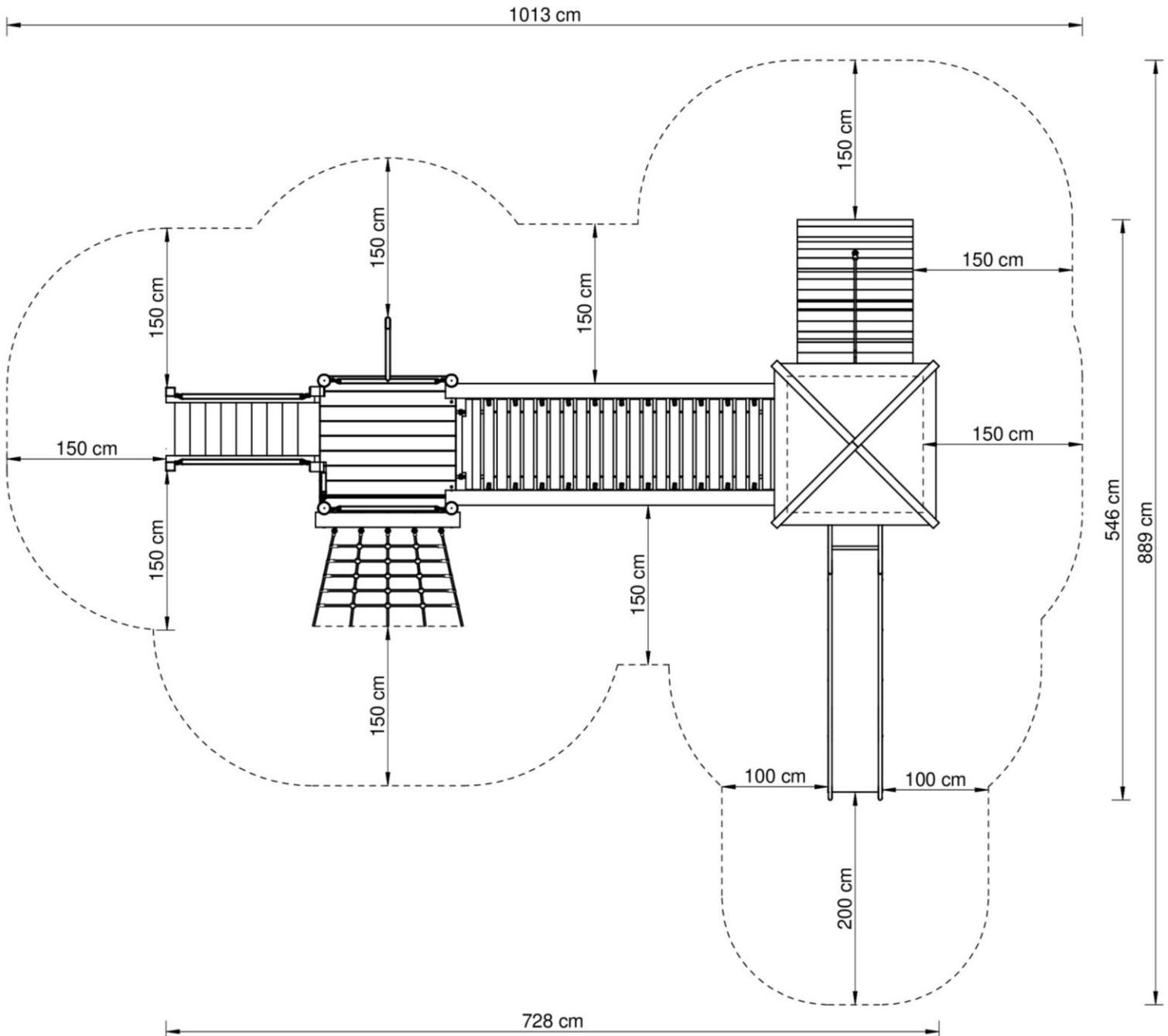



PLAYPARC



NEOSPIEL®

So funktioniert {Spiel}

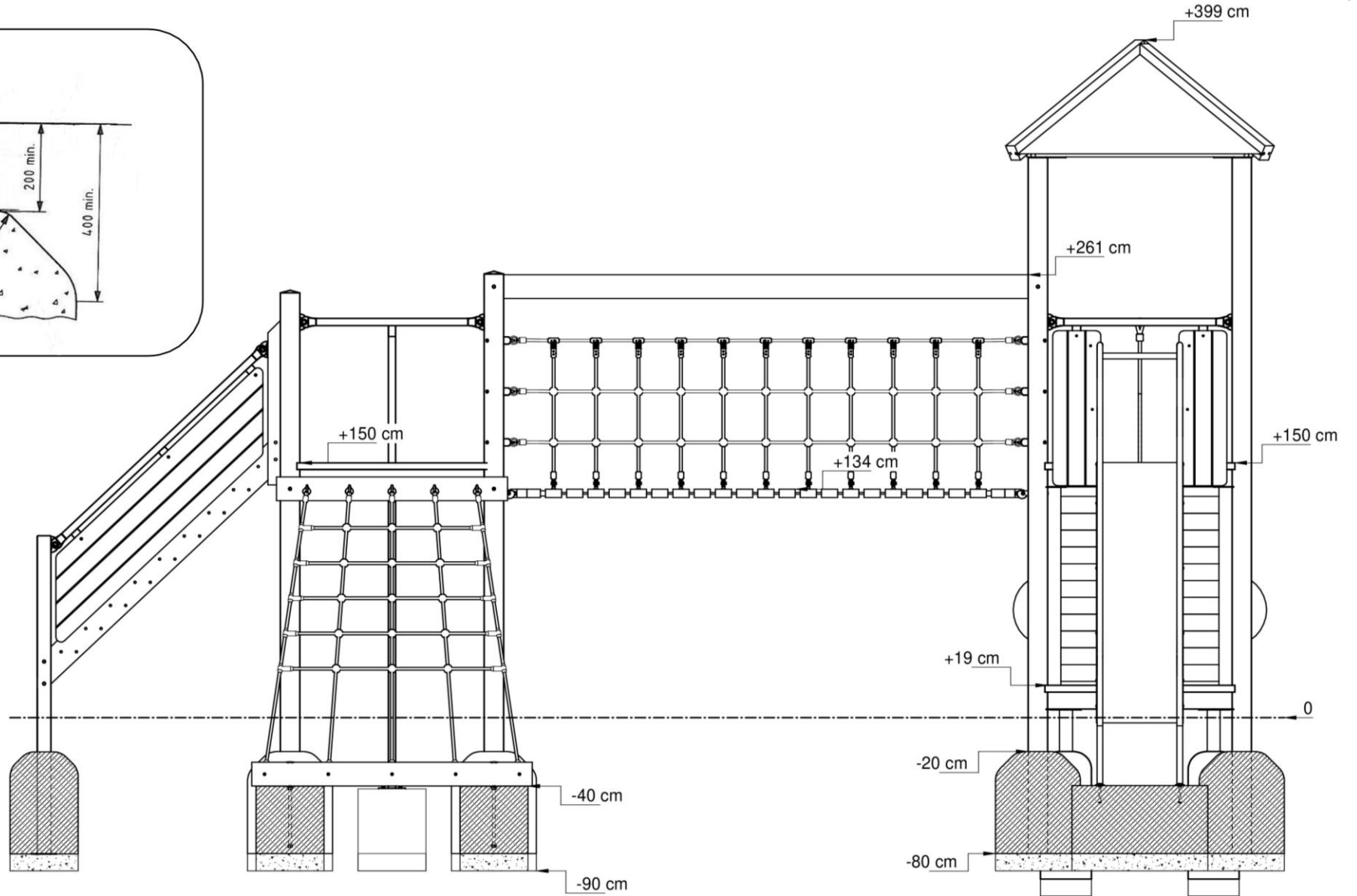
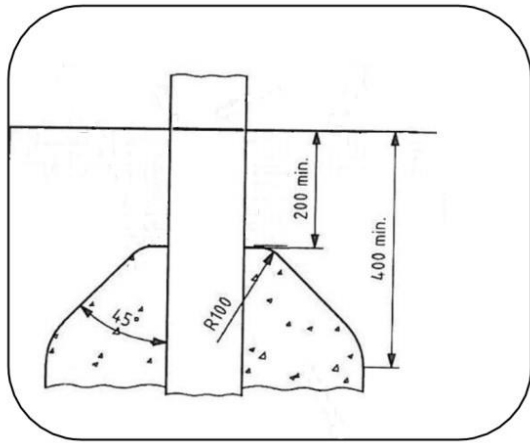

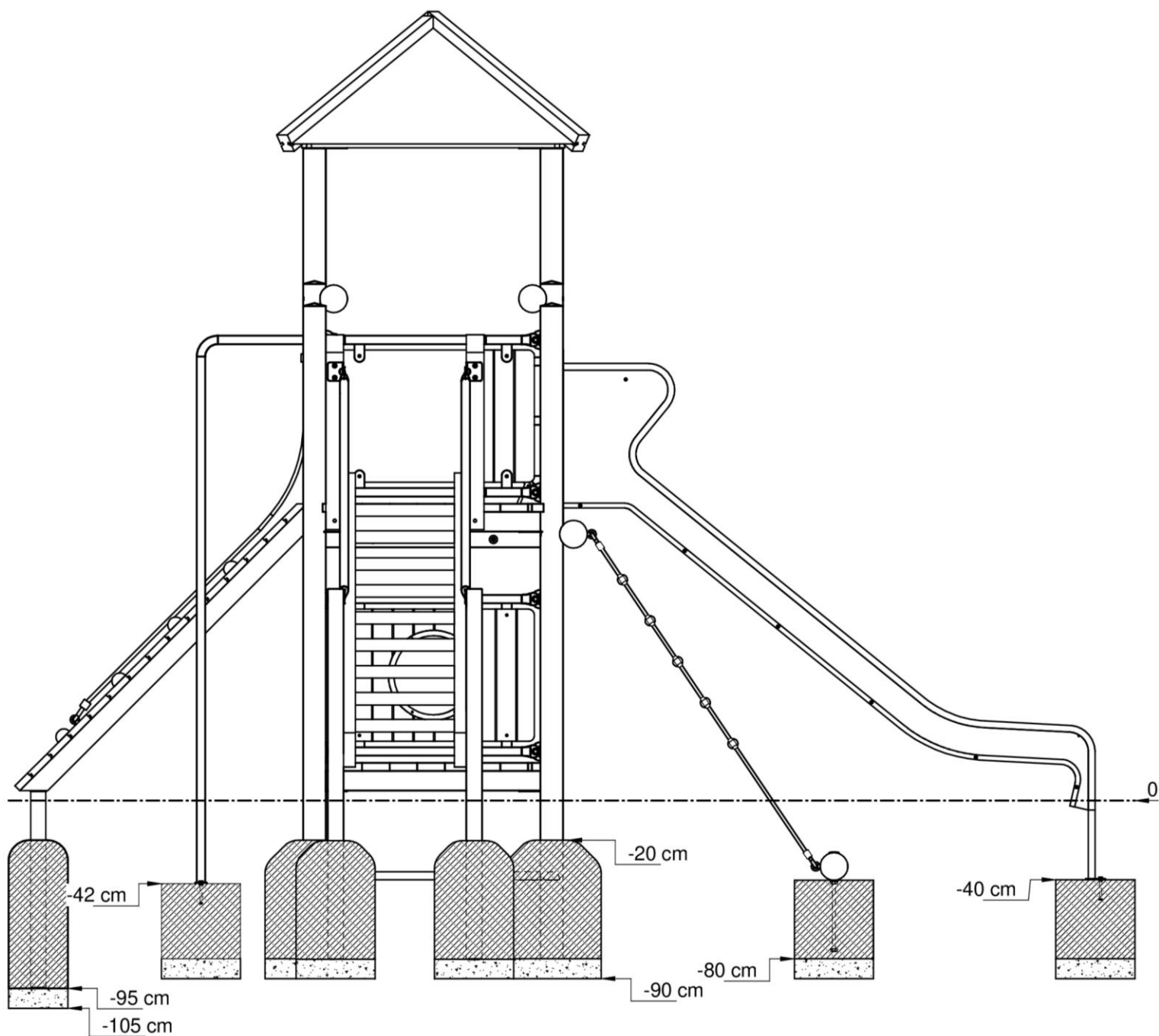



dimension "cm"

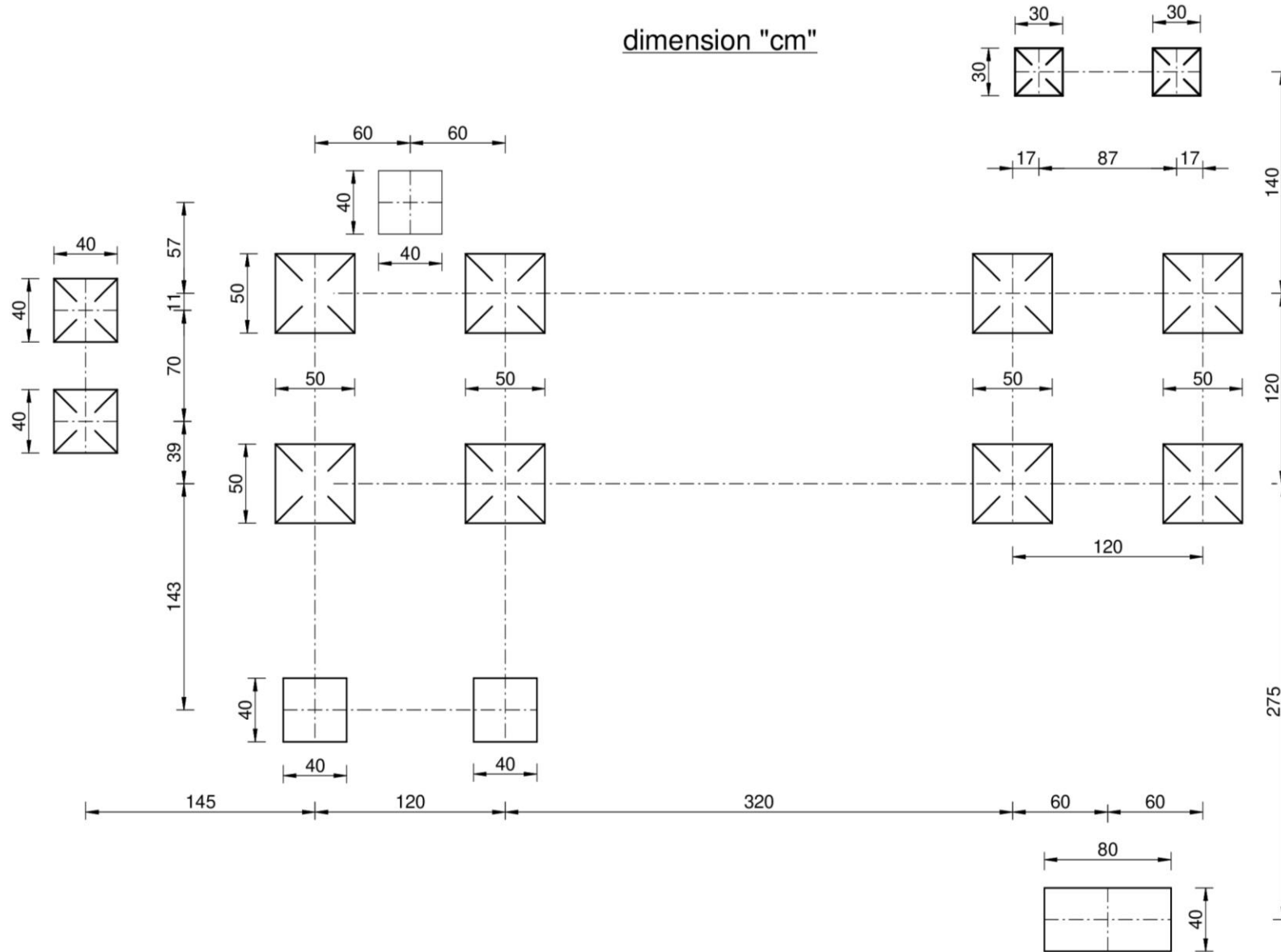





PLAYPARC

1

NEOSPIEL®

So funktioniert {Spiel}

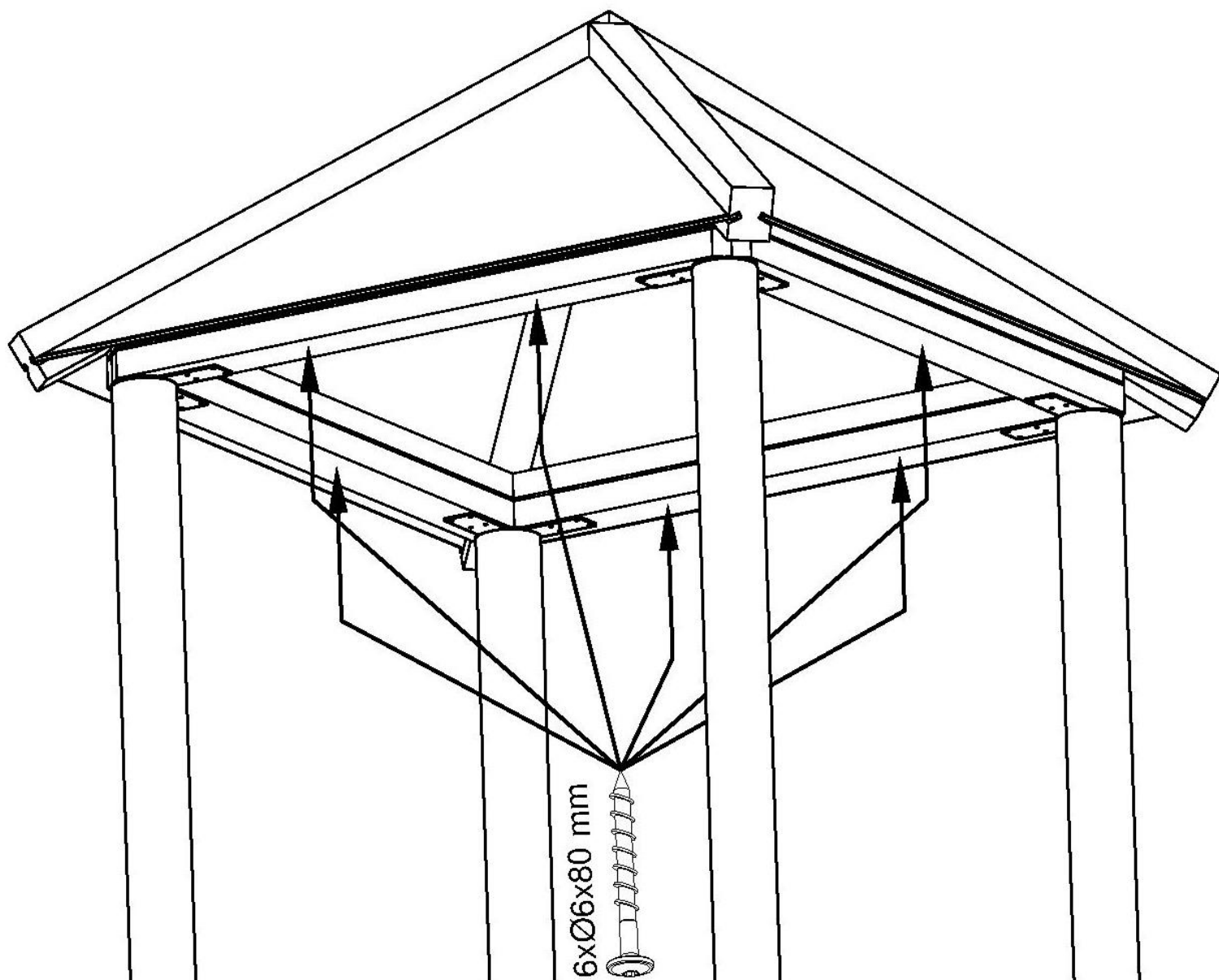



PLAYPARC

2

NEOSPIEL®

So funktioniert {Spiel}

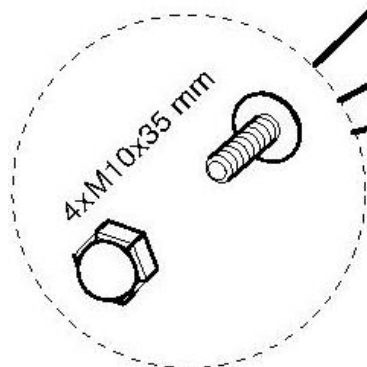
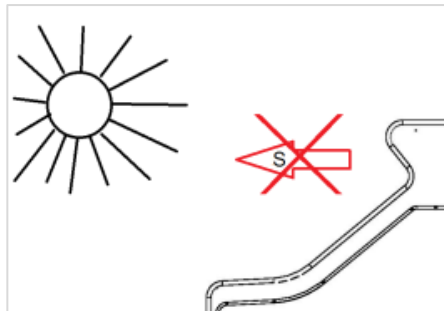

4x M10x35 mm

2x Ø8x80 mm

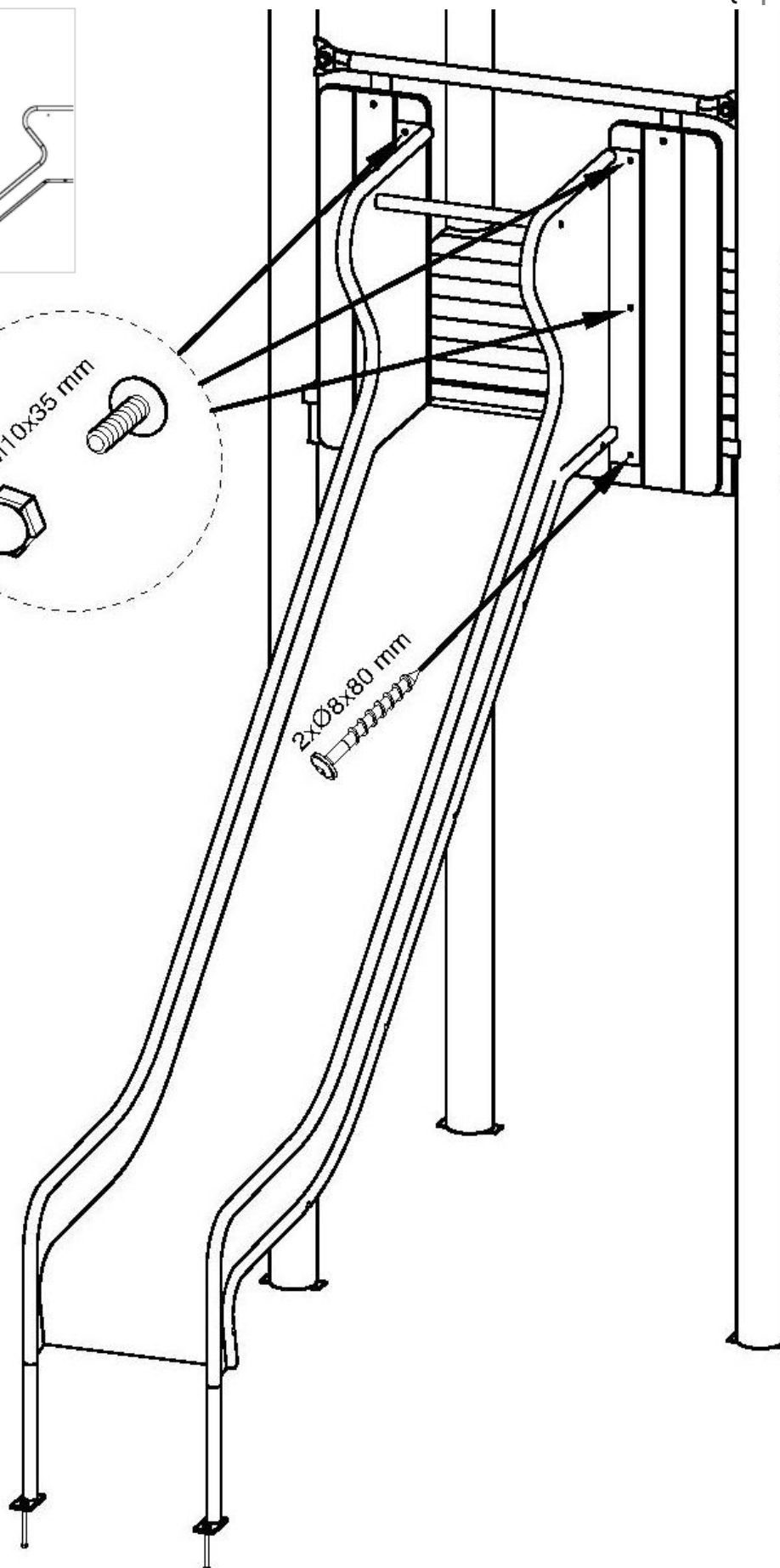



PLAYPARC

3

NEOSPIEL®

So funktioniert {Spiel}

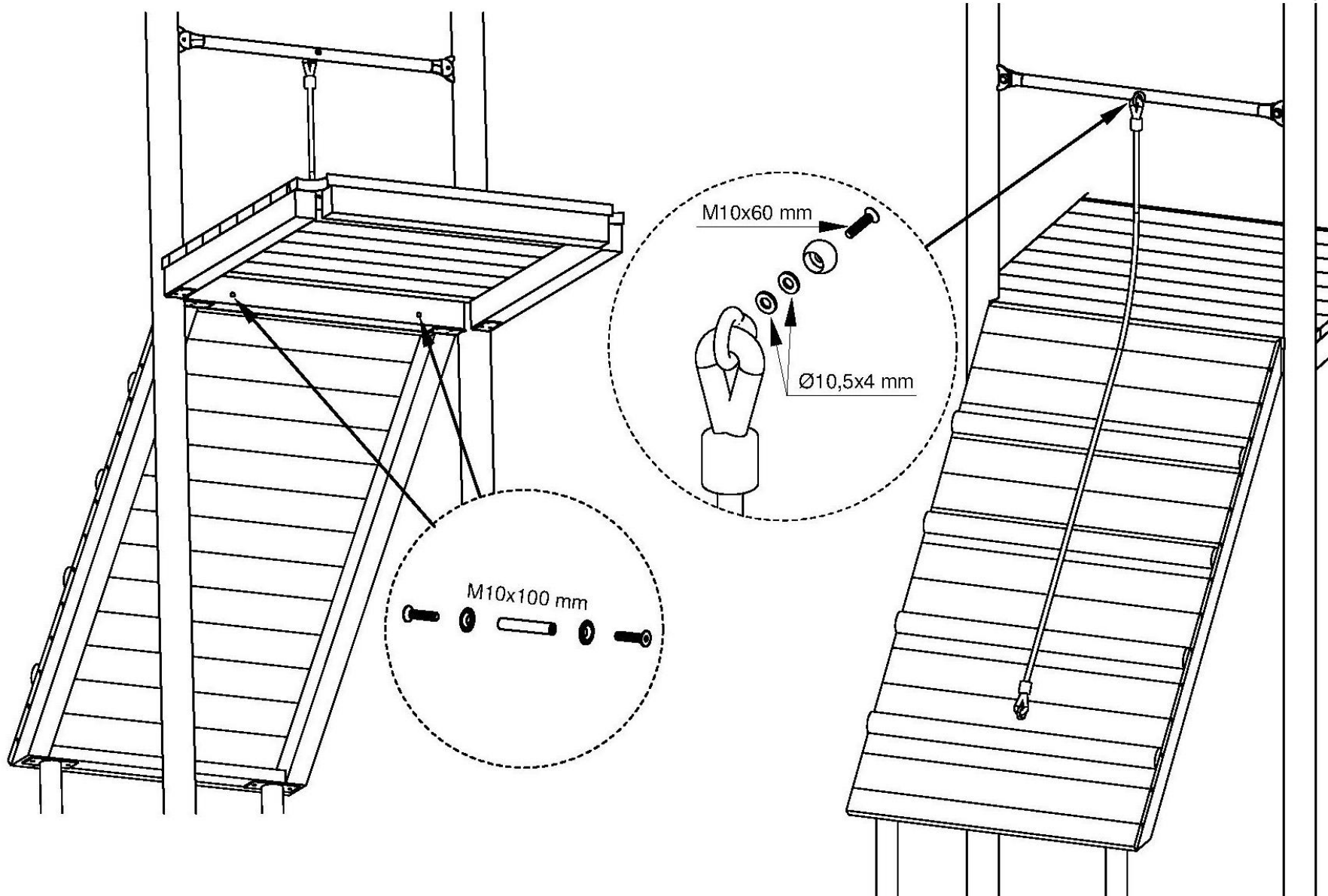



PLAYPARC

4

NEOSPIEL®

So funktioniert {Spiel}

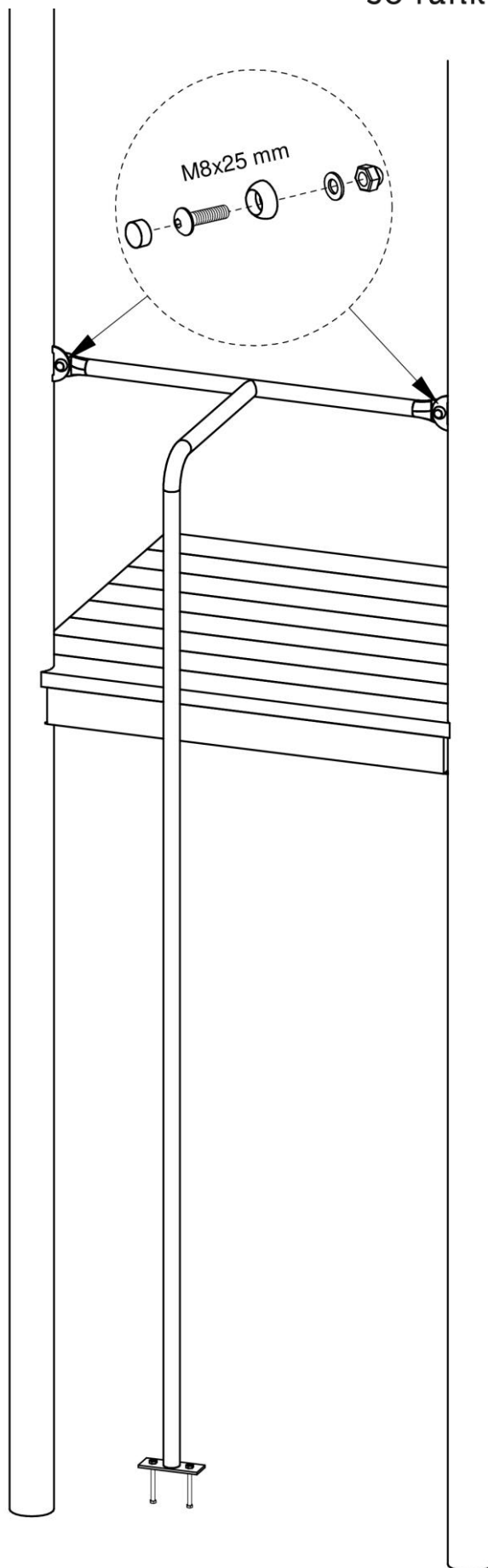



PLAYPARC

5

NEOSPIEL®

So funktioniert {Spiel}

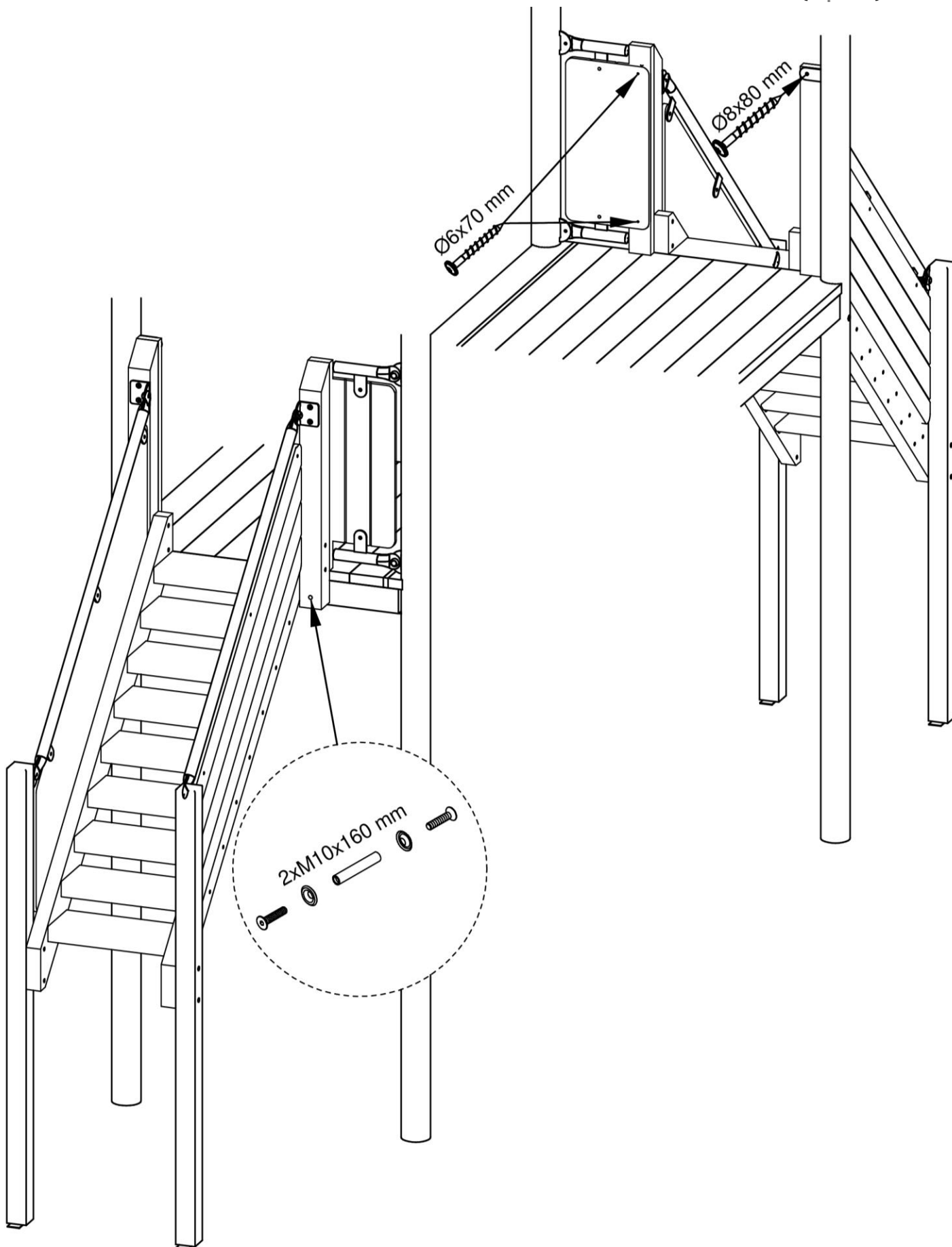



PLAYPARC

6

NEOSPIEL®

So funktioniert {Spiel}

